

**Utilities**

**WHITE PAPER**

August 2014

## **TELEPROTECTION OVER MPLS WIDE-AREA NETWORKS**

High-Performance Platforms from Industry Leaders  
Help Electric Utilities Migrate to Next-Generation Packet-Switched  
MPLS Wide-Area Networks for Transmission Grids



For more information,  
contact Joint Alias

# Table of Contents

- Introduction ..... 1**
- The Challenges of Adapting Older Networks for the Evolving Transmission Grid.....1
- Communication Channel Requirements to Support Line Differential Protection .....2
- Siemens SIPROTEC Protection and Automation Solutions .....5
- Cisco MPLS WAN Solution.....5
- Siemens and Cisco Solution Benchmark Results ..... 7
- Summary ..... 9
- Why Siemens? ..... 9
- Why Cisco? ..... 9
- About Siemens..... 9
- About Cisco .....10

## Introduction

Utilities face major challenges today with their communication networks: Maintain reliability of supply. Renew the aging infrastructure. Ramp up Smart Grid applications. Comply with regulations.

This paper explains how packet-switched networks (PSNs) can achieve these goals better than traditional circuit networks like Plesiochronous Digital Hierarchy (PDH) and SONET/SDH, and how this solution is key to reducing the total cost of ownership (TCO) of communication networks.

IP Multiprotocol Label Switching (IP/MPLS) is a PSN technology based on open standards and widely deployed in service provider and enterprise corporate networks with proven benefits: security, performance, and flexibility. As a consequence, many utilities choose IP/MPLS now to converge several applications, including critical and real-time applications, in one single network to reduce cost and complexity.

As an example, this paper gives an overview of Siemens Protections solutions using communication links and Cisco® IP/MPLS technologies. It shows how IP/MPLS meets the stringent requirements of current differential protection based on validation tests with Siemens SIPROTEC relays and a Cisco ASR 900 Series Aggregation Services Router.

## The Challenges of Adapting Older Networks for the Evolving Transmission Grid

As critical infrastructure operators, utilities are responsible for maintaining electric power delivery and controlling grid equipment in all circumstances. To achieve this goal, most of them have traditionally relied on private time-division multiplexing (TDM)-based solutions such as SONET/SDH. These technologies deliver carrier-class performance and support the deterministic traffic critical for grid operations, and initial deployment is relatively straightforward.

However, because of changing system requirements and equipment end of life, TDM infrastructures no longer adequately support long-term needs of utilities. Many are built and operated for specific applications or solutions, creating siloed infrastructures that make it more challenging to integrate new systems and operational processes. At the same time utilities are increasingly planning for a future based on IT and Smart Grid applications requiring advanced telecommunications systems. Many such applications use PSNs for communicating information and control signals. Examples include Supervisory Control and Data Acquisition (SCADA), physical security, closed-circuit television (CCTV), voice, remote maintenance, workforce management, advanced metering infrastructure (AMI), distribution grid management systems (DMS), and enterprise corporate traffic. The acceleration of packet-based applications is also led by IEC 61850 standards with the support of IP and Ethernet native architectures and new use cases such as substation automation, System Integrity Protection Schemes (SIPS), Wide-Area Measurement Systems (WAMS), and so on (Figure 1).

The pattern of traffic is also evolving significantly; WANs have to connect many types of locations moving from traditional point-to-point communications toward a full-mesh matrix of data traffic between substations, distribution grid, control centers, data centers, and corporate offices. Packet-based networks are designed to provide flexible network topology and multipoint communications.

To support this rapidly expanding set of applications within constrained budgets and increasing demands for operational efficiency, many utilities are taking steps to evolve present TDM-based infrastructures to packet systems. Packet-based networks are designed to offer more and better functions and higher levels of service for applications while continuing to deliver reliability and deterministic (real-time) traffic support.

Cisco MPLS is a proven standards-based WAN technology. This solution for electric utilities is designed as a flexible network foundation that supports both TDM-based services and packet-based application requirements. Cisco MPLS networks provide flexibility that is unmatched in the industry, making it possible for utilities to protect their current investments while planning a communications infrastructure roadmap for years into the future. Cisco MPLS provides many advantages:

- **Interoperability:** Support for traditional, older, and TDM systems; integration with private and public networks
- **Security:** End-to-end segmentation between applications and organizations (utility, customers, and partners)
- **Performance:** High availability, scalability, fast convergence (<50 ms), multicast, and bandwidth (10 Gigabit Ethernet)
- **Quality:** Application-level service-level agreement (SLA), quality of service (QoS), and traffic engineering
- **Operations:** Reduction of management tools, ease of operations, and network visibility and predictability

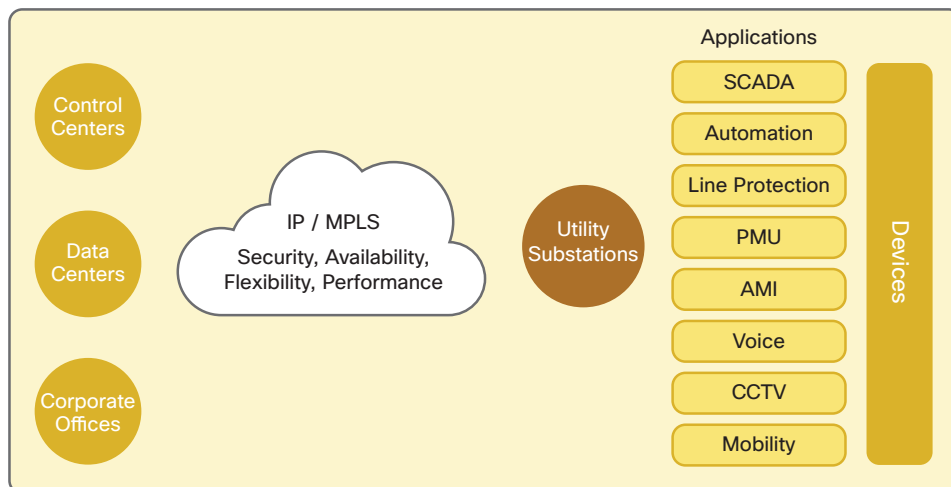

Figure 1. Smart Grid Applications

## Communication Channel Requirements to Support Line Differential Protection

Despite dedicated connections between the devices, SIPROTEC relays also support different communication backbones. To introduce this possibility, different types of TDM-based interfaces like C37.94 or E1 were either integrated in the devices or made accessible using special communication converters. TDM technology in the communication backbone is now widely used and has proved to fulfill the communication requirements of line differential protection algorithms. The main advantage for line

differential protection with TDM networks lies in the fact that these networks work synchronously, enabling connected protection devices to rely on a deterministic, nearly jitter-free communication system.

In line differential protection, the difference between the currents at two line ends must be calculated. It is not possible to connect all current transformers to one relay, because line differential protection is used over large distances. Therefore, the current values must be transmitted through a communication interface. To compare the current values of two ends of a line, it is essential that the measured values be synchronized. Otherwise a phase angle shift resulting from comparing currents from different time instances would create a false differential current, leading to a false tripping of the protection device. Figure 2 illustrates the differential protection principle.

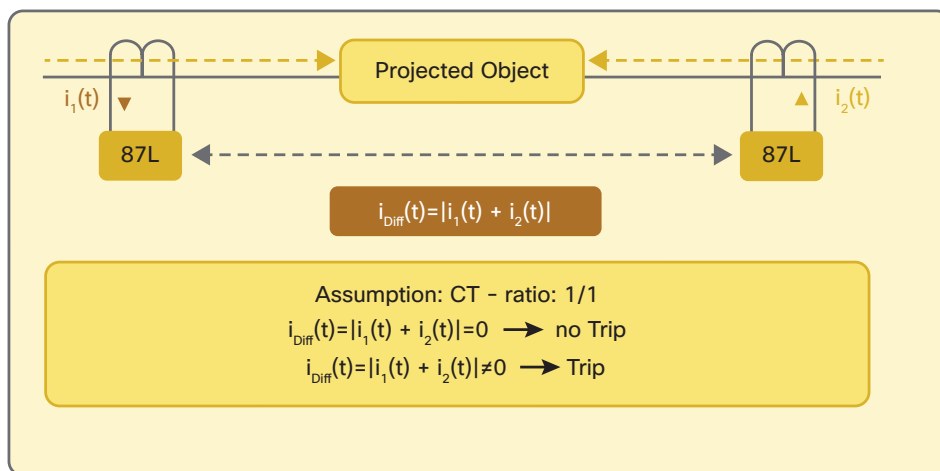

Figure 2. Differential Protection Principle

There are two different approaches to synchronize the protection devices. First, the relays can be synchronized using an external synchronization signal. This signal currently is generated mostly by high-accuracy Global Positioning System (GPS) clocks. GPS delivers this precise time signal to GPS clocks on both ends of the line, which are directly connected to the relays. The disadvantage of this method is obvious: Not only does the communication between the relays have to work, but also a high-accuracy GPS signal must be available. The system relies on both media to work properly. To increase reliability and reduce equipment at the same time, Siemens included a channel-based synchronization in the relays. In this method the devices exchange time synchronization messages through the communication system that is already used for measured value exchange. For the algorithm of time synchronization, it is essential that the network works symmetrically, meaning with the same delay time in both directions, and jitter-free. Of course a certain amount of asymmetry and jitter always exists. As long as asymmetry and jitter are within some limits of tolerance, an uncertainty in time synchronization exists but the line differential protection algorithm is not affected. If the uncertainty of the time synchronization gets too high, the result is a reduction of protection sensitivity.

Another parameter of the network communication system that influences the behavior of the protection is the delay introduced by the communication system. The delay does not influence the behavior of the protection algorithm as long as it is constant. However, the communication delay adds directly to the device operating time. It is beneficial to reduce this time, and switched networks provide the opportunity to do so.

In contrast to TDM-based communication networks, PSNs do not set up dedicated connections but are built of components forwarding a message on a hop-by-hop basis. This setup leads to variances in propagation time due to variation of processing and queuing delays in network nodes. If channel-based synchronization is used, this jitter must be minimized in order to guarantee accurate time synchronization of the relays. The PSN network components should provide a certain level of determinism. This determinism is performed using hardware-aided switching technology and a carefully engineered priority management. To minimize the queuing effects and the resulting jitter, it has proven reasonable to put differential protection in an exclusive priority class and give this class the highest priority. This setup not only doesn't affect performance but also guarantees reliability. Even in the case of a network overload, differential protection messages are still transmitted within the guaranteed limits of jitter and delay over the backbone and the protection will work. Figure 3 illustrates the line differential protection architecture.

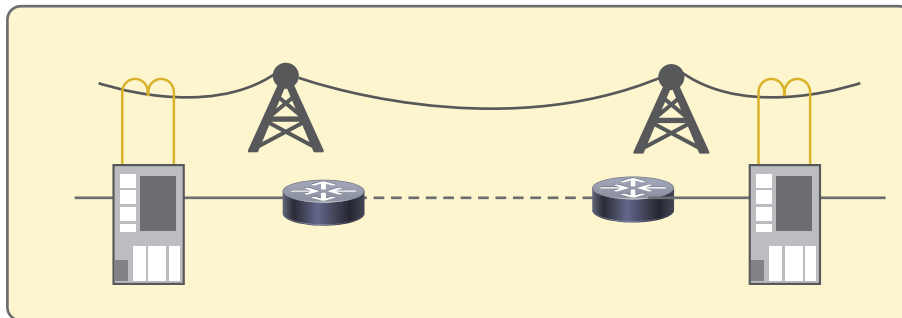

Figure 3. Line Differential Protection Architecture

Siemens' relays are developed to fit perfectly in differential protection applications using a TDM-based backbone. It has been proven that SIPROTEC is also well-suited for new PSNs. It enables customers to modernize their communication equipment while keeping the protection relays. Thus an investment when using SIPROTEC should be compatible with future networks. The advanced channel-based synchronization allows usage of the communication backbone to synchronize distant devices without additional effort. The Siemens multi-end differential protection allows flexible protection schemes beyond single-line differential protection.

Special communication connection monitoring functions included in the Siemens protection devices allow engineers to monitor both protection functions and network behavior. The network monitoring can be used in both the commissioning phase and while operating the devices.

## Siemens SIPROTEC Protection and Automation Solutions

The SIPROTEC 7SD and 7SL relays provide full scheme differential protection and incorporate all functions usually required for the protection of power lines. They are designed for all power and distribution levels, and they protect lines with two to six line ends. The relays are designed to provide high-speed and phase-selective fault clearance. They can use fiber-optic cables or digital communication networks to exchange telegrams, and also include special features for the use in multiplexed communication networks. These features help improve reliability and availability of the electrical power system.

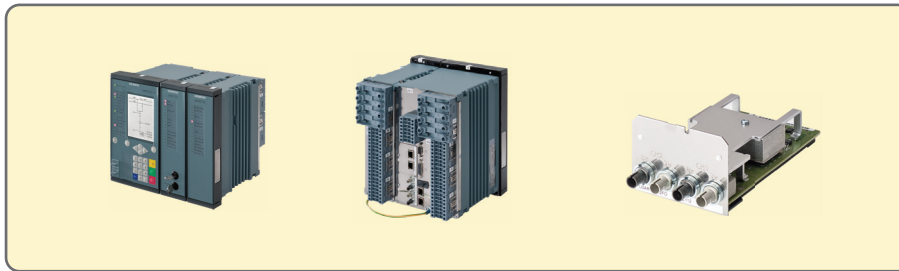

Figure 4. Siemens SIPROTEC 5 Protection and Automation Devices

The relays are suitable for single- and three-phase tripping applications for two to six line ends. Also, transformers and compensation coils within the differential protection zone are protected, as are serial and parallel-compensated lines and cables. The relays can be employed with any type of system grounding.

As main two protection the SIPROTEC 7SL devices also include an optional full-scheme distance protection. Several line differential protection schemes help ensure maximum selectivity and high-speed tripping time.

The units measure the delay time in the communication networks and adaptively match their measurements accordingly.

A special GPS option allows use of the relays in communication networks, where the delay time in transmit and receive paths may be quite different. If the communication method is changed, flexible retrofitting of communication modules to the existing configuration is possible.

The SIPROTEC 7SD devices tolerate loss of one data connection in a ring topology. The differential protection scheme is fully available in a chain topology.

## Cisco MPLS WAN Solution

Cisco ASR 903 and ASR 902 Aggregation Services Routers (Figure 5) provide the baseline for creating a scalable, resilient, and manageable network that can transport mission-critical operational applications and corporate IT traffic in a single, converged, next-generation network infrastructure.

- Powered by the Cisco Carrier Ethernet ASIC and designed specifically for deterministic low-latency transport, the Cisco ASR 900 Series routers deliver line-rate performance for all interfaces across all line cards along with advanced hierarchical quality of service (HQoS) functions. This allows for mission critical teleprotection and grid monitoring, protection and control applications to coexist with other services under oversubscribed full traffic load conditions.

- The ASR 900 platforms provide future-proof scalability. Current throughput is up to 128 Gbps with the second-generation RSP2A, and the chassis are scalable to over 360 Gbps with future RSP generations.
- This hardened platform is designed to operate in utility substations with harsh environmental conditions. It is IEC 61850-3 and IEEE 1613 (fans required) compliant operating from –40C to 65C and 5 to 95% humidity.
- The high-available and modular design of the platform provides optional intra-chassis hardware redundancy for the Route Switch Processor (RSP) and AC/DC Power Supply Unit (PSU). Dual RSP configurations (ASR 903) support software redundancy with In Service Software Upgrade (ISSU). When operating in redundant configurations, the RSPs and AC/DC PSUs are field replaceable and can be online inserted and removed (OIR) while the system is operating. Fans are N+1 redundant and in-service replaceable.
- The platform supports the full suite of timing functions required by modern grid applications and support for TDM/SONET/SDH migration. The RSPs offer integrated support for Building Integrated Timing Supply (BITS), 10 MHz, 1 Pulse Per Second (1 PPS) and Time Of Day (TOD) interfaces. The platform supports synchronous Ethernet (SyncE), IEEE 1588-2008, and can act as the clock source for network clocking of TDM and SDH/SONET interfaces.
- The platform supports a diverse set of multiservice interface modules including 1GE Copper or SFP, 10GE, T1/E1, OC3/STM-1, OC12/STM-4, serial Async/Sync interface options, and support is planned for 4-wire E&M and C37.94 interfaces.
- The platform supports MPLS/IP and MPLS Profile Transport Profile (MPLS-TP) transport options and enables them to co-exist in a single network, allowing utilities to choose the preferred transport option for each Smart Gridapp application.
- The Cisco ASR 900 Series Routers employ Cisco IOS XE Software, a modular operating system, designed to provide feature velocity and powerful resiliency. The platforms provide a set of differentiating features for utilities: Multi-drop data bridging with Raw-Socket for serial tunneling of SCADA, TDM circuit emulation with DS0 grooming for channel bank transport, MPLS pseudowire transport and teleprotection, Layer 2 and Layer 3 MPLS VPN services for newer IEC 61850 based monitoring, protection and control applications, and IP multicast and multicast VPN services for synchrophasor based applications.

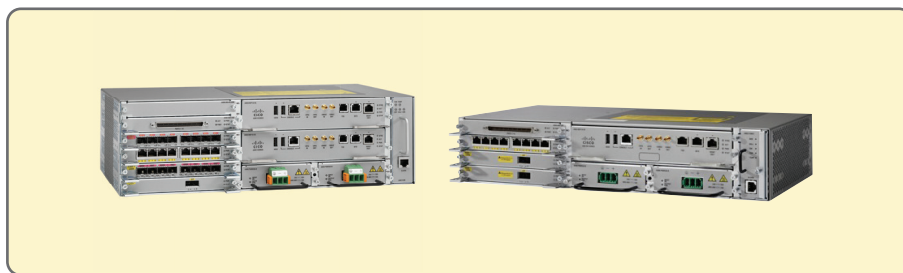

*Figure 5. Cisco ASR 900 Series Aggregation Services Routers*

Cisco ASR 900 Series Routers are supported in Cisco Prime Carrier Management, the comprehensive end-to-end network management solution that drastically simplifies the design, provisioning, and management of carrier-grade networks.



## Siemens and Cisco Solution Benchmark Results

The test bench with Siemens and Cisco solutions reproduces an 87L Differential Line Protection application between two substations. Each substation hosts a SIPROTEC relay and a Cisco ASR 903 substation router.

The SIPROTEC relay measures the current values and exchanges current and synchronization information with a peer relay through synchronous serial communications. The Cisco ASR 903 packetizes the serial communication from SIPROTEC, forwards the circuit emulation toward the IP/MPLS network, and does the reverse on the other end. The Cisco ASR 903 is connected to SIPROTEC with a G.703 E1 through a converter at a speed of 512 kbps (64 kbps x 8 DS-0 channels.) These Cisco ASR 903 substation routers (Ra and Rb in Figure 6) can use two paths between the substations: one path is a 1-hop direct Gigabit Ethernet link, and the backup path is 10 hops across 9 Cisco ASR 903 backbone routers. The 10-hop backup path is used in case of failures along the 1-hop primary path.

In order to simulate real network scenarios, an impairment tool is set up to introduce delay and jitter (2–4 ms) and an Ethernet traffic generator is used to congest the network. Figure 6 shows the test setup with two substations.

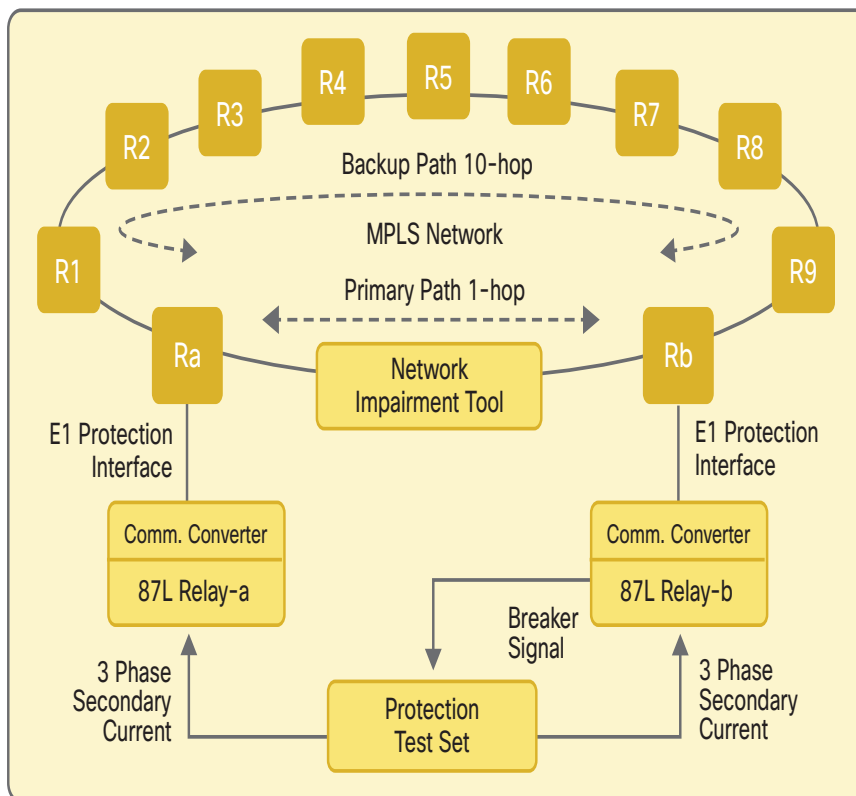

Figure 6. Test Setup with Two Substations

The SIPROTEC default maximum values are set as per-relay vendor recommendations: 5-ms latency, 0.5-ms latency asymmetry, and 0.5-percent error rate.

A variety of simulations were performed to determine if reliable protection could be achieved in such a network. Protection times were measured and reliability assessed. The effects of numerous potential threats were established, and overall protection performance was evaluated. The test results showed that a packet-switched network based on the Cisco ASR 900 can achieve a high level of determinism and surpass protection requirements for delay, symmetry, jitter, and packet loss.

Figure 7 compares the latency of the direct 87L communication channel without IP/MPLS (0.07 ms), and with one hop (1.82 ms) and 10 hops (1.95 ms). The results are far below maximum values.

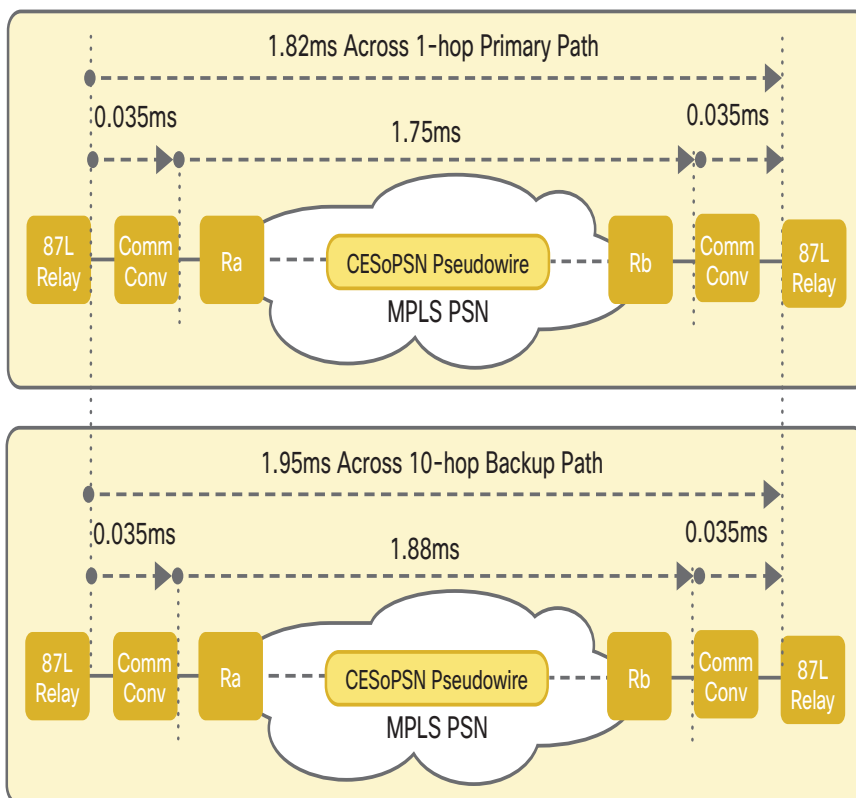

Figure 7. 87L Communication Channel Latency over PSN

Additional tests showed that the 10-hops path dropped from 1.95 to 0.016 ms when 1 Gigabit Ethernet was used instead of synchronous serial-based 512 kbps. *These results demonstrate that the main factors that consume delay budget are relay protection interface types and speeds, not the PSN itself.*

During the tests, the traffic generator injects a full traffic load profile on the Gigabit Ethernet link to cause congestion. QoS functionality is activated on the Cisco ASR router to provide strict priority and reserved bandwidth to the teleprotection application. This QoS functionality efficiently compensates the jitter and packet delay variation (PDV) inherent in PSNs. The maximum value during the test observed was 0.12-ms jitter.

For more details of tests, refer to the IEEE paper, “Proving Viability of Line Current Differential over Packet Switched Networks” by Silvio Roesler, Siemens Energy, and Ruben Lobo, Cisco Systems, published in proceedings of the 67th Annual Conference for Protective Relay Engineers, March 2014.

### **Summary**

The use of Ethernet packet-switched networks for protection promises the same advances in reliability and reduced costs experienced in telecommunications systems. Carrier-grade PSNs can be reliably engineered to meet the constraints imposed by 87L. Siemens SIPROTEC and Cisco ASR 903 together deliver technical excellence and business value by providing a modern communication platform and protection system that meets the immediate needs of today and anticipated evolving requirements far into the future.

### **Why Siemens?**

The Siemens Smart Grid Division (Nuremberg, Germany) offers power providers, network operators, industrial enterprises, and cities an end-to-end portfolio with products and solutions to develop intelligent energy networks. Smart Grids enable a bidirectional flow of energy and information. They are required for the integration of more renewable energy sources in the network. In addition, power providers can run their plants more efficiently with data gained from Smart Grids. Software solutions that analyze data from Smart Grids will continuously gain importance. Therefore the division uses in-house developments in addition to systems from software partners. For further information please visit: <http://www.siemens.com/smartgrid>.

### **Why Cisco?**

Many utilities are adopting MPLS as a strategic WAN solution that provides a flexible, scalable framework to support expansion and change. Cisco is the leader in end-to-end communications solutions and standards development, bringing more than 25 years of industry networking experience to each utility project. Cisco provides the design expertise, industry partnerships, and a portfolio of standards-based products and solutions to optimize MPLS within energy operations. These scalable, secure implementations support applications both today and well into the future, allowing operations managers to confidently plan for tomorrow’s capabilities while continuing to maximize existing technologies.

### **About Siemens**

For more than 100 years, Siemens has demonstrated a unique success story of innovation and quality in protection technology. Since the beginning of the 20th century and the pioneering days of protection technology, customer requirements have been in a continuous process of change. Siemens has consistently transformed these new requirements into innovative products and solutions—always working closely with its customers and always one step ahead of the competition. Siemens’ strategy of innovation, combined with a total focus on its customers and their benefits, has made Siemens the market leader.

## About Cisco

Cisco (NASDAQ: CSCO), the worldwide leader in networking, is helping the energy industry modernize the electrical grid from generation to distribution to consumption—with highly secure, reliable, and scalable communications solutions. The Cisco Connected Grid solutions include: Transmission and Substation, Field-Area Network, Grid Security, and Data Center and Grid Operations. To learn more, please visit: [www.cisco.com/go/utilities](http://www.cisco.com/go/utilities).



© 2014 Cisco and/or its affiliates. All rights reserved. Cisco and the Cisco Logo are trademarks of Cisco Systems, Inc. and/or its affiliates in the U.S. and other countries. A listing of Cisco's trademarks can be found at [www.cisco.com/go/trademarks](http://www.cisco.com/go/trademarks). Third-party trademarks mentioned are the property of their respective owners. The use of the word partner does not imply a partnership relationship between Cisco and any other company.